



SANDEN

Delivering Excellence

A/C COMPRESSOR GUIDE AND PRACTICAL TIPS



Founded in 1943



Sandeno was first established as Sankyo Electric Company by Kaihei Ushikubo as a manufacturer of bicycle lamps, with a distinctive owl trademark.

1950s

Introducing refrigeration



Sankyo Electric produced an open-type refrigeration showcase for business use - the first of its kind in the industry.

1970s

Automotive air-conditioning



First generation compressor



Sankyo Electric entered a technical alliance with Mitchell Corporation, accessing the automotive market by producing compressors for passenger cars in 1970. With this new industry came a new corporate identity - SANDEN

1980s

Becoming a global enterprise



In 1981, Sanden developed the world's first scroll-type compressor for the automotive industry.

Sanden Vendo machine



Sanden acquired Vendo, creating sales and production bases worldwide, to become a truly global enterprise and industry leader.

1990s/2000s

Automotive industry leader

Electric type - original



Hybrid type



Drawing on the successes from strategic alliances that paved the way into the automotive industry, Sanden became known as a key compressor supplier for major OEMs.

Tackling environmental issues

Akagi Forest



Sanden developed open scroll-type automotive compressors to help prevent ozone layer destruction. For these environmentally friendly services, Sanden was awarded by the Agency for Natural Resources and Energy.

The first Swash Plate



Sanden developed their first Swash Plate compressor for improved passenger car comfort. To meet emerging market needs, Sanden entered the heavy vehicle market and developed their first heavy duty and super heavy duty compressors.

2010s

Electrification



HVAC

Electric type - Gen1

Already an automotive market leader, Sanden developed a full electric compressor for use in passenger cars. Sanden became the market leader for truck integrated parking cooling and started to supply full HVAC assembly to key truck customers.

2018



Electric type - Gen2 Evo

Sanden celebrated 75 years of business in 2018. With passionate, knowledgeable employees and innovative strategies, Sanden is committed to Delivering Excellence to every customer, every time.

2021

A new alliance



Sanden and Hisense entered into a new business alliance, and are working together to create a world-leading company in the fields of AI, battery thermal management and connected cars.

The Future

Stronger Together



Since the core values of Sanden and Hisense match, the two companies will work in synergy to create a better, more environmentally friendly future for the next generation.

A/C SYSTEM OVERVIEW

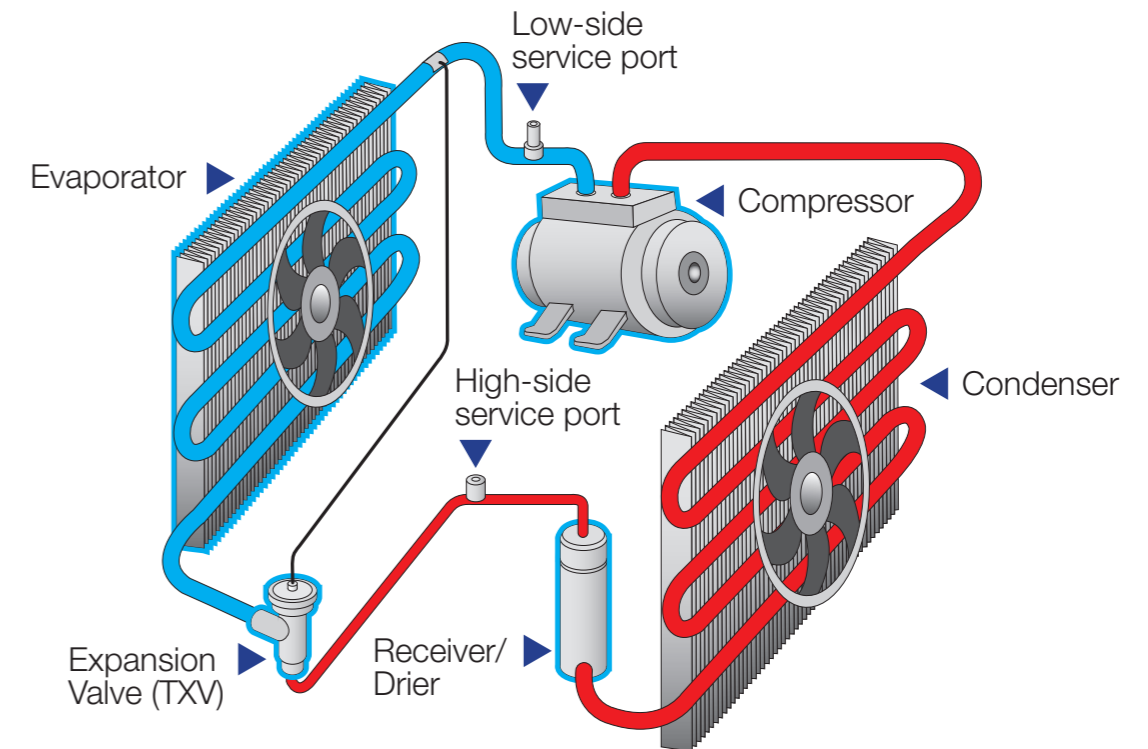

A/C common malfunctions ▶ A/C malfunctions explained

Compressor seizure

All compressors designed to run with compressor oil will fail in case of poor oil/refrigerant arrival to the compressor, as the compressor will not be lubricated/refrigerated. For example, if an engine is run without oil or coolant, the engine will fail.

During normal compressor operation, the components are lubricated with an oil film, which reduces friction and allows for the dissipation of heat. The compressor moves a mixture of oil and refrigerant through the A/C system. This mixture lubricates and refrigerates the compressor's internal components that are in movement. The system refrigerant acts as a heat carrier and aids in the component lubrication and removal of heat from the components. Poor oil lubrication will lead to an increase in the temperature and dilation of the components. As a result of the dilation, the space around the components will be reduced/eliminated, and so the oil film will disappear. The oil film elimination will create metal-to-metal contact and so seizures will occur.

For **SDH compressors**, the commonly seized areas are the central ball and the piston rod sockets. Centerball seizure is an example of a seizure which results when the compressor and/or centerball is deprived of adequate lubrication and cooling. This failure usually results in the centerball melting and becoming welded to the fixed gear.*

In the case of **SDV compressors**, the typical seized area will be the balance ring.

* Sanden warranty applies to compressors that have been diagnosed as having a manufacturing fault.

In the case of **PX compressors**, the typical seized area will be the piston shoes and swash plate.

In the case of **TR compressors**, the typical seized area will be the central area of the scroll.

Seizures occur as a result of lack of lubrication and cooling. This condition can be caused by the following:

- Lack of refrigerant flow due to inadequate charge.
- TXV blockage or malfunction.
- Thermostat failure.
- No air flow to evaporator (blower fan motor failure).
- Lack of refrigerant and/or oil due to a leak or oil trap.
- Lack of return oil due to too long a circuit or system undercharge.
- Blockage in system due to contamination in system.
- Defective centerball or gear mating surface.
- Liquid slugging due to improper system charging.
- Charging liquid refrigerant into compressor (washes off oil film from around the centerball when the compressor is connected).

Clutch slipping

Clutch slipping is a condition that occurs when the armature plate fails to engage and rotate in synchronization with the clutch rotor. Clutch slippage occurs as a result of high torque requirement conditions, very low voltage supply conditions or clutch wearing. The field coil when energized becomes an electromagnet which then magnetizes the clutch rotor and armature plate. Friction and magnetic attraction cause the armature plate and clutch rotor to lock together (clutch engagement) and rotate the compressor shaft.

Clutch slipping specifically refers to a situation that occurs when the armature plate fails to lock together properly with the rotor. The armature will then tend to drag (slip) against the rotor surface. This dragging (slipping) results in intense friction and heat. As the slipping continues, the heat causes deformation of the armature plate. In the case of a rubber armature, clutch slipping may lead to melting of the rubber damper and can result in a subsequent failure of the entire clutch mechanism.

Possible causes of **clutch slipping** and overheating:

- Liquid migration to crankcase when the A/C system is off.
- Liquid slugging -will cause high shaft rotation torque. This inhibits rotation of the armature plate and leads to slipping.
- Contamination on friction surfaces - will diminish the coefficient of friction between the two mating surfaces and result in slipping of the armature.
- Low voltage to the field coil - causes a reduction in the strength of the magnetic field of the field coil.
- System overpressure - will cause high shaft rotation torque. This inhibits rotation of the armature plate and leads to slipping.
- Engine harness defective connection - may result in insufficient current being applied to the field coil.

Customer damage

Customer damage refers to instances where compressor failure is caused by improper installation, mishandling and / or incorrect system application.

Compressors are susceptible to damage whenever failures occur within the A/C system. System fail-safes such as Pressure Relief Valves (PRV), Thermal Protection Switches (TPS) and High / Low pressure cut offs are often used to reduce the possibility of compressor damage under abnormal system conditions. These devices limit damage to A/C components by making the system inoperable whenever a severely abnormal condition develops.

When a returned compressor is analyzed for failure responsibility, the physical condition of the compressor is examined to determine if the compressor was subjected to handling damage and/or improper installation. If the compressor has external indications, or shows evidence that it was subjected to extreme conditions which caused the failure, then the cause of the failure may be determined to be customer damage.

Customer damage includes but is not limited to the following:

- Compressor ear mount damage occurs from an incorrect gap between the bracket and the ear mount. In some situations, moving the installation bushes to the recommended position is required prior to fitting the compressor.
- Overtorquing of hose fittings which can result in stripped threads or broken ports.
- Improper field service. Parts that are incorrectly replaced or installed can result in subsequent compressor failure. A typical checklist involves:
 - Receiver drier **MUST** be replaced every time the A/C system is inspected
 - A/C flushing in case of oil contamination
 - Replacing the refrigerant and oil
 - Expansion valve replacement (if needed)
 - Any oil leaks must be repaired
- Mechanical damage to the clutch, scratches, nicks, dents, air gap modified, lead wires pulled out, pinched, cut etc.
- Mechanical damage to the compressor cylinder block.
- The addition of non approved chemicals which may cause system and / or compressor malfunction.
- Improper packaging or handling of the compressor.
- Improper modification of the compressor i.e. painting, plating, polishing etc.

Moisture contamination

refers to a failure which results from conditions which can occur when moisture is introduced into the A/C system.

The A/C compressor is designed to perform efficiently under specific controlled conditions. If contaminants are introduced into the system they act to reduce compressor efficiency, effectiveness and durability.

Moisture as used in this context refers to water in any form (solid, liquid or gas). When moisture is introduced in the A/C system, it may combine with the system refrigerant to form an acidic solution which can erode internal compressor components. In this case moisture does not cause direct compressor failure; the failure results from the failure of a part which has been weakened as a result of the effects of rust and/or corrosion.

Moisture can create ice at the expansion valve level which can cause erratic functioning of the valve. As a consequence of this malfunction, liquid refrigerant arrives at the compressor or a low amount of the refrigerant/oil mixture arrives at the compressor.

Moisture can also cause corrosion of internal parts, such as the valve plate.

During normal compressor operation, the pistons compress refrigerant gas in the cylinders. Moisture

in the system can lead to liquid slugging. Liquid slugging is a condition which occurs when liquid is allowed to enter one or more cylinders. Because liquid is practically non-compressible, the compressor seals may be compromised when the pistons attempt to compress the liquid. Liquid slugging can lead to permanent valve damage and reduced compressor efficiency.

Moisture contamination occurs as a result of moisture being allowed to enter and remain in the A/C system. This condition can be caused by the following:

- Improper vacuuming of system.
- Contaminated system components.
- Contaminated refrigerant and/or oil.
- Saturated or malfunctioning drier.
- Water permeability through the hoses.
- Leaving uncapped hoses or any A/C components exposed to the air for long periods of time.
- Leaving the suction/discharge caps off the compressor
- Receiver drier must be replaced according to A/C system manufacturer recommended service period

There are 4 primary identifiers of moisture contamination.

1. Contaminated Oil = Contaminated oil is identified by its colour.

Clear/yellow oil - new or used oil.

Light grey oil - Common within the first few hours of use.

Light green/yellow oil - oil contains a leak detector additive.

Silver/grey oil - indicates the presence of larger metal particles in the oil.

Black oil - small metal particles are present in the oil.
Brown oil (carbonized oil) - the A/C system has overheated due to condenser malfunction, blockage or airflow restriction through the condenser, defective pressure switch or lack of oil/refrigerant.

Orange oil (this is applicable only to Sanden oil) - the oil has become contaminated by humidity.

2. Rust = Rust may occur on internal steel compressor components that are exposed to moisture for extended periods.

3. Slugged Valves = A slugged valve is one that has been permanently deformed as a result of liquid slugging.

4. Copper Plating = The presence of copper plating generally occurs when there is a high moisture content in the A/C system.

TROUBLESHOOTING TIPS

Undercharge - not enough gas in the system

- 1** Medium to high compressor discharge temperature.

The reason this happens is because the fluid coming into the compressor is hot.

Part of the function of the suction gas is to cool the compressor. If the gas enters hotter than normal, it will also be hotter than normal when it exits.

- 2** High suction superheat

The reason you will have higher superheat is because the expansion device will be starved of liquid due to the undercharging. When the expansion device is starved, it will pass both liquid and vapour and will not be able to control superheat. As there is not enough refrigerant in the system, all the refrigerant arriving at the evaporator is evaporated at an early stage, and will continue to absorb heat through the evaporator which results in high superheat.

- 3** Low condenser subcooling

Subcooling is a key factor to determine the correct refrigerant charge. The subcooling is increased when refrigerant charge is increased. If there is no subcooling, there will be liquid and gas refrigerant at the expansion device inlet.

- 4** Low suction pressure

Suction pressure will become lower because of the demand the compressor requires. The compressor will act like a vacuum pulling the gas through the evaporator causing low suction pressures.

Overcharge - too much gas in the system

- 1** High compressor discharge temperature

The higher discharged temperature is caused by the increase of the discharge pressure.

- 2** High discharge pressure

The subcooled liquid will back up in the condenser and reduce the amount of surface area for the gas to cool. This will cause higher pressures.

- 3** High condenser subcooling

Because of the backed up liquid at the bottom of the condenser, this will cause the liquid to reach high subcooling temperatures.

- 4** Normal superheat

The TXV will control the superheat. There may be a slight variation during the initial opening, but it will self-correct and control the superheat.

Non-condensable - liquid in the system

- 1 **High compressor discharge temperature**
The higher discharged temperature is caused by the increase of the discharge pressure.
- 2 **High discharge pressure**
The subcooled liquid will back up in the condenser and reduce the amount of surface area for the gas to cool. This will cause higher pressures.
- 3 **High condenser subcooling**
Because of the backed up liquid at the bottom of the condenser, this will cause the liquid to reach high subcooling temperatures.
- 4 **Normal superheat**
The TXV will control the superheat. There may be a slight variation during the initial opening, but it will self-correct and control the superheat.

Restricted expansion device - blockage in TXV

- 1 **Low suction pressure**
Suction pressure will become lower because of the demand of refrigerant the compressor requires. Compressor will act like a vacuum pulling the gas through the evaporator causing low suction pressures. If the TXV is closed the pressure drop will be higher, and so the evaporation pressure will be lower due to higher pressure drop.
- 2 **High superheat**
During the evaporation the temperature of the refrigerant remains constant. Once all the refrigerant is evaporated, the temperature start to rise as consequence of the heat exchange, and so superheat is increased.
- 3 **High discharge temperatures**
Discharge temperatures will be higher because of the higher superheat.

Dirty or restricted air flow over condenser - not enough heat transfer

- 1 **High compressor discharge pressure**
Discharge pressure will be higher due to the perfect gas law: $P.V = n.r.T$. If the gas temperature increases due to restricted air flow and we have the same volume, so the pressure will be increased.

- 2 **High compressor discharge temperature**
As pressure increases so will temperature, this is due to the higher compression ratio.

Dirty or restricted air flow over evaporator - not enough heat transfer

- 1 **Low compressor discharge pressure**
The restricted air flow on the evaporator will reduce the heat load to the evaporator, as so less energy will be available to evaporate the refrigerant. The expansion valve has to ensure the proper superheat values. That means that the refrigerant must be evaporated and superheated at the evaporator outlet. If the air flow is small, it means that less refrigerant can be evaporated, and so the expansion valve will close to restrict the arrival of the refrigerant to the evaporator. If the TXV is closed, the pressure drop will be higher, and so the evaporation pressure lower. If less refrigerant enters the expansion valve, the condenser pressure is reduced due to a lack of refrigerant reaching the condenser.
- 2 **Low superheat**
In an A/C system with a calibrated orifice, the superheat will be lower because the heat transfer in the evaporator will be lesser. Without heat load, there is no superheat.
- 3 **Cold compressor crankcase**
The suction refrigerant will still be cold because of no heat transfer. This will cause the crankcase to become cold.

Clutch not engaging - Compressor will not turn on

- 1 **No voltage to the coil**
- 2 **Relay switch is broken**
- 3 **Coil thermal fuse activated**
- 4 **Short circuit diode**
- 5 **Poor electric connection at the compressor terminal**

COMPRESSOR OILS

SP-10 - PAG

SP-10 - PAG oil is compatible with R134a refrigerant. This oil is commonly used in off-highway, truck applications and cars using variable compressors with R134a refrigerant.

Available in the following sizes:
200L Drum, 18L Drum, 1L Can, 250cc Tin

SP-15 - PAG

SP-15 - PAG oil is common in compressors made in Sanden USA, where it replaces SP-20, and is compatible with SP-10.

Available in the following sizes:
18L Drum, 250cc Tin

SP-A2- PAG

SP-A2 - PAG oil can be used with both R134a refrigerant and the new R1234yf refrigerant. SP-A2 is the oil of choice in genuine Sanden electrical compressors.

Available in the following sizes:
200L Drum, 18L Drum, 1L Can, 250cc Tin

AC Edge

AC Edge oils are marketed as an affordable alternative to SP-10 and SP-20 compressor oils.

PAG 46 - double end-capped oil similar to SP-10 for use in aftermarket A/C systems.

PAG 100 - double end-capped oil similar to SP-20 for use in aftermarket A/C systems.

POE 68 - dedicated for use in transport refrigeration systems.

Available in the following sizes:
250cc Bottle, 1L Bottle

REFRIGERANTS

R12

For many years, R12 was the standard refrigerant for automotive air conditioning. However, in 1996 it was banned due to its rapid depletion of the ozone layer.

R134a

The best replacement for R12 refrigerant is generally considered to be R134a. It was a favourable alternative as it has zero ozone depletion causing potential, but it has a high GWP.

R1234yf

A new replacement for R134a, R1234yf refrigerant has a GWP value of 4. Vehicles using R1234yf will have less greenhouse effect footprint due to lower GWP of R1234yf refrigerant.

R404a

R404a is a replacement for R502 and R22 refrigerants. With GWP above 2500, the use of R404a is now forbidden in new equipment and restricted in older equipment.

R452a

A replacement for R404a and R507, R452a has a GWP of 2140. It is commonly used in low temperature transport refrigeration applications.

Refrigerant flush

The change between refrigerants is a relatively straightforward one. The old refrigerant must be removed from the system and left in the can, as it is illegal to knowingly vent refrigerants into the air. The compressor oil in the A/C system must also be changed before the system is charged with the new refrigerant.

REFRIGERANT/OIL FLUSHING

Why do I need to flush?

- To remove particles and contamination from the A/C system.

When do I need to flush?

- In the case of compressor damage, particles will reach the condenser. The current condenser technologies use micro-channels which will be clogged by the particles generated by the compressor, having as a consequence poor condenser performance. In some cases is possible to flush and in other cases is necessary to replace the condenser. If the receiver drier breaks, desiccant particles will contaminate the system. These particles must be removed. Contaminated oil must be removed by flushing.

What do I use for flushing?

- Solvents or refrigerant can be used to flush. For an A/C system with an electric compressor, Sanden advises against using a solvent to flush, as it can damage the copper coil coating.

Flushing equipment types

- 1 Refrigerant recovery recycle machines containing a flushing circulating pump to solvent-clean R134A and R1234yf.
- 2 A closed loop flushing machine in which the circulated flushing fluid is returned to a reservoir for filtering and continued circulation. Most of these machines provide a pulsing action to dislodge particles that are stuck in small passageways.

Safety

- Do not use flammable fluids.
- Protect eyes with safety goggles.
- Wear chemical resistant gloves.
- Use approved fluids - CFCs R-11, 113 or 115 and Methyl Chloroform also known as 1,1,1, Trichloroethane are not acceptable as per the Clean Air Act.

Acceptable Flushing Fluids

- Fluids designated for A/C flushing should be used and may be either solvent or lubricant based. Fluids used to flush the system should meet SAE specification J2670 to insure compatibility with refrigerant, oil and any materials used in the A/C system.

Components to Flush

- Hoses, hard lines and heat exchangers can be flushed. DO NOT flush the compressor, accumulator or receiver drier, refrigerant lines with mufflers, thermal expansion valve or orifice tube because residual flushing fluid cannot be removed from these components and they restrict the flow of flushing agent through other components.

Flushing Rear Evaporator Lines

- Debris is distributed throughout the entire A/C system so it is important to flush the rear lines. The rear expansion valve can be gutted or drilled out and remounted so that the rear evaporator and hoses can be back-flushed as an assembly. After blowing out the flushing fluid and residual fumes a new thermal

expansion valve should be mounted. For systems with TXV, the filter is at the condenser outlet, and it should stop the debris particles. If the filter is broken, then debris particles will contaminate the system, and the liquid line and TXV can become clogged. Checking the condenser outlet and receiver drier inlet and outlet is very important. There should not be any contamination particles after the TXV. Contamination can be understood by considering particles (solids) and by water (flushing liquid, etc.) If the system is contaminated, the entire A/C system must be flushed.

Importance of Flushing Direction

- "Back flush", or flushing in the reverse direction to normal flow, is the most effective. The plate fins used on many front and rear evaporators have many small passages which are difficult to clean without a strong pulsating reverse flow.

How long do I flush?

- Closed loop procedure, flush until the flushing fluid leaving the A/C components are clean. Manual pressurized gun method requires a minimum of three times, but more if exiting fluid is not clean.

Removal of Residual Flushing Fluid before Evacuation and Charge

- The primary vacuum pump must be protected from flushing fluid and fumes. Purging of flushing solvent is necessary before connecting the recovery recycle machine to evacuate and charge the A/C system. The best method is to allow nitrogen to flow through the components. If nitrogen is not available, clean and dried compressed air can be blown through the flushed components until the flush liquid is evaporated. The components can be left open during the night to allow the remainder of the flushing liquid to evaporate.

Replacing the compressor:

- 1 Remove the oil plug from the failed compressor and drain as much oil as possible from the suction and discharge ports and from the crankcase into a suitable container. Drain for about 3 minutes while turning the front shaft nut one half turn every minute. Also slightly tilt the compressor back and forth a few times to help the oil reach the oil drain hole.
- 2 Measure and record the amount of oil extracted by the refrigerant recovery machine.
- 3 Drain oil from the new compressor following step 1.
- 4 Replace some of the new oil back into the new compressor in an amount equal to the oil recovered from the old compressor and from the machine. Dispose of the rest of the oil according to local regulations.
- 5 Re-install oil plug. The aluminium seal seat and O-ring must be clean and not damaged. Torque to 11-15 ft-lb (15-20 Nm, 150-200 kg-cm). Be careful not to cross thread the oil plug.

COMPRESSOR FAMILIES

SDH

SD5H09

Standard 5 piston wobble plate fixed displacement design compressor with magnetic clutch

- 4kW cooling capability with 90cc displacement
- Speed range 700 - 6500 rpm
- Suitable for R134a refrigerant with Sanden SP-10 oil
- Ear mount design for easy fitting to bracket
- Available in 12 and 24 volt
- Numerous clutch and cylinder head options

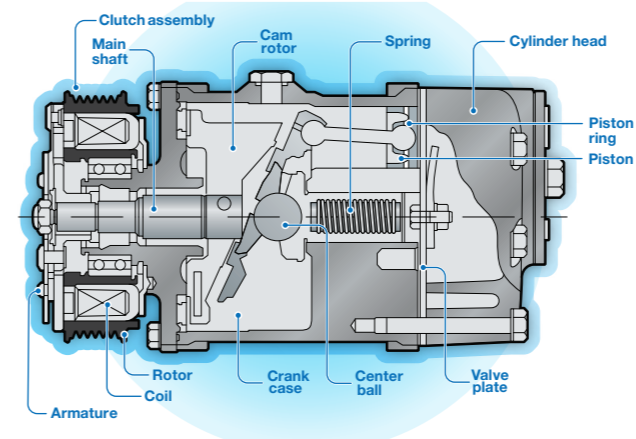

SD5H09 Performance

Pressure Dis/Suc : 1.7(mPa) / 196(kPa)[gauge]
Sub Cool / Super Heat : 0 / 10(K)

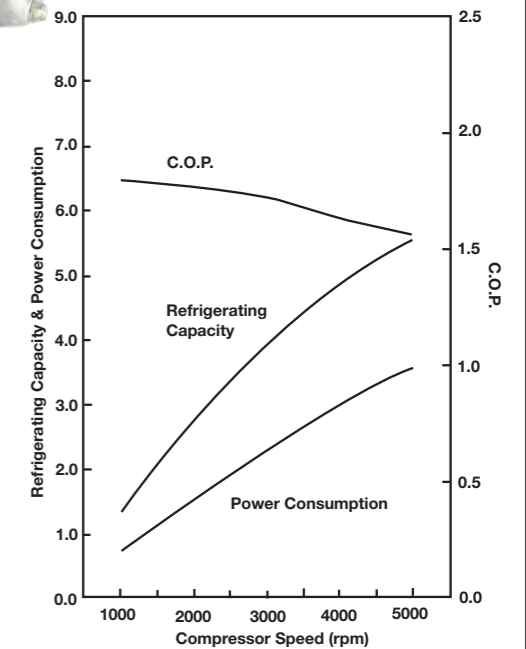

SD5H11

Standard 5 piston wobble plate fixed displacement design compressor with magnetic clutch

- 5.5kW cooling capability with 110cc displacement
- Speed range 700 - 6000 rpm
- Suitable for R134a refrigerant with Sanden SP-10 oil
- Ear mount design for easy fitting to bracket
- Available in 12 and 24 volt
- Numerous clutch and cylinder head options

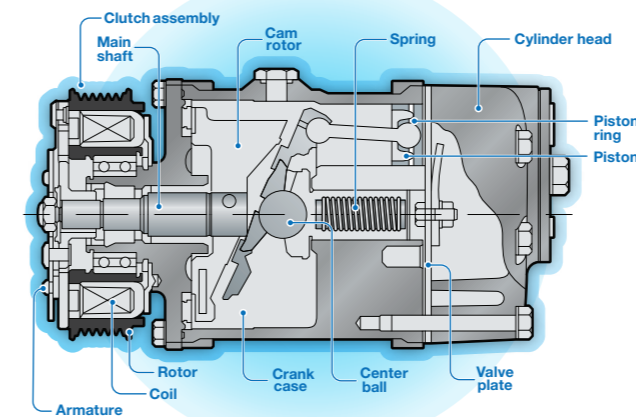

SD5H11 Performance

Pressure Dis/Suc : 1.7(MPa) / 196(kPa)[gauge]
Sub Cool / Super Heat : 0 / 10(K)

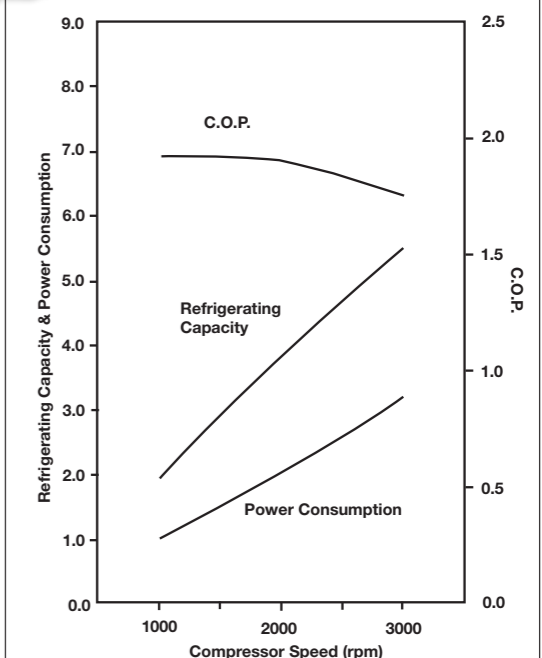

SD5H14

Standard 5 piston wobble plate design compressor

- 7kW cooling capability with 140cc displacement
- Speed range 700 - 6000 rpm
- Suitable for R134a refrigerant with Sanden SP-10 oil
- Ear mount design for easy fitting to bracket
- Available in 12 and 24 volt
- New cylinder block design for lower cost
- Numerous clutch and cylinder head options

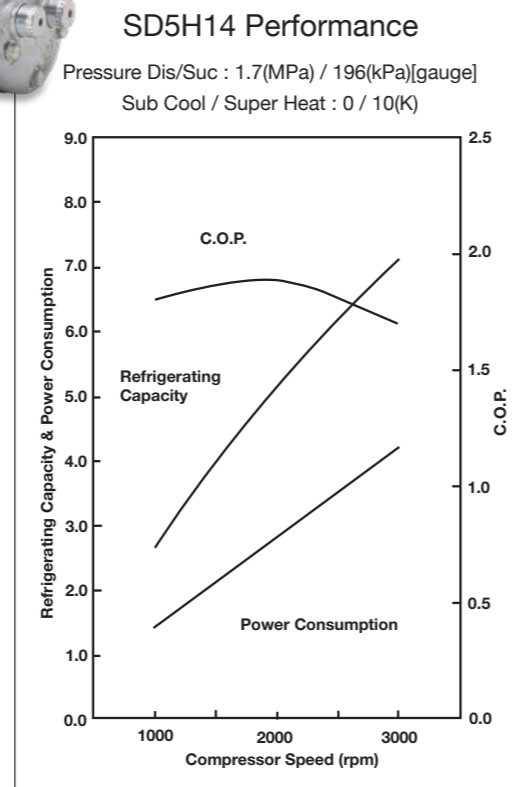
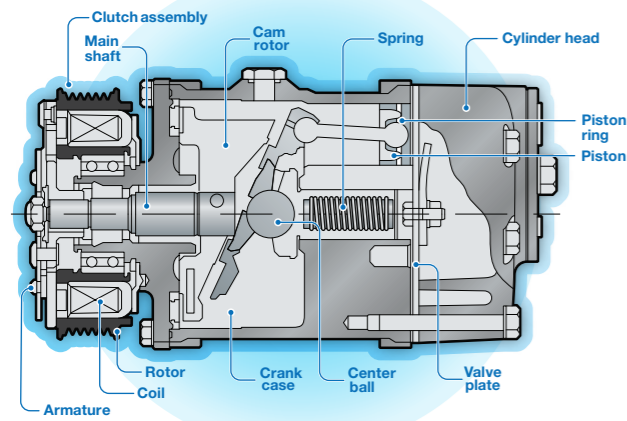

SD7H15

Standard 7 piston wobble plate design compressor with magnetic clutch

- 8kW cooling capability with 155cc displacement
- Speed range 700 - 6000 rpm
- Suitable for R134a refrigerant with Sanden SP-10 oil
- Ear mount and direct mount options
- Available in 12 and 24 volt
- Numerous clutch and cylinder head options

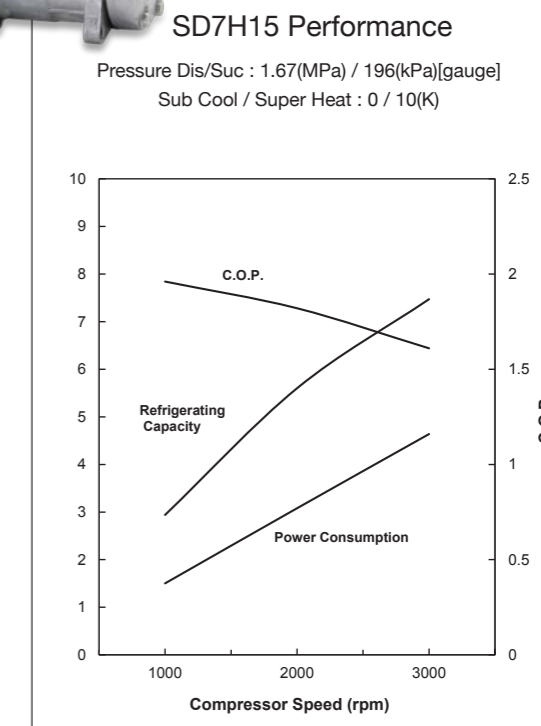
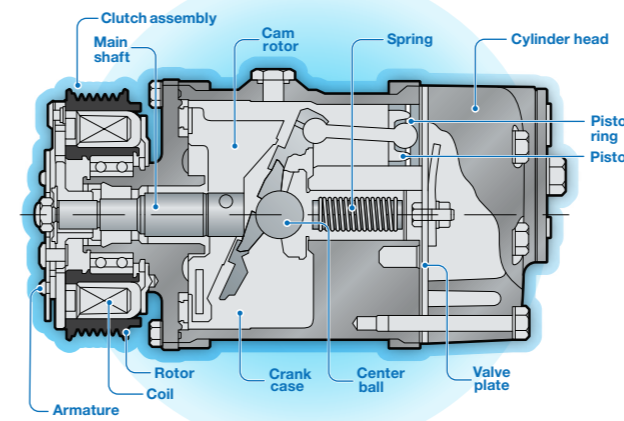

SD7H13

Standard 7 piston wobble plate design compressor with magnetic clutch

- 6.5kW cooling capability with 130cc displacement
- Speed range 700 - 6000 rpm
- Suitable for R134a refrigerant with Sanden SP-10 oil
- Ear mount and direct mount options
- Available in 12 and 24 volt
- Numerous clutch and cylinder head options

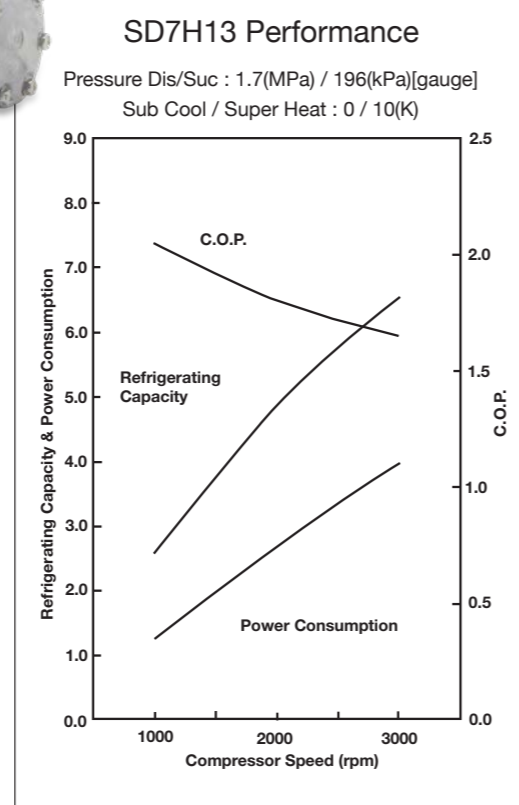
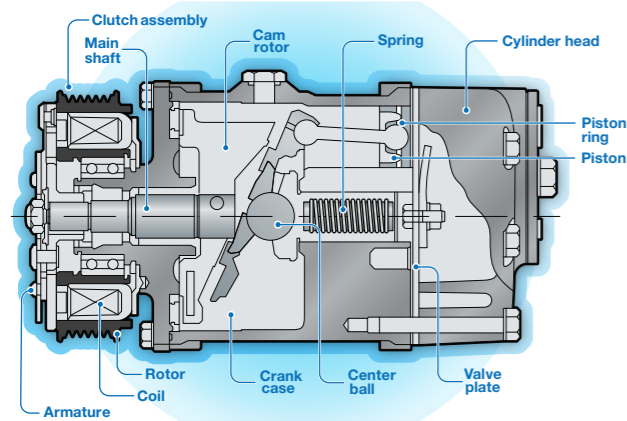

SD7H15 Flex

Standard 7 piston wobble plate design compressor with magnetic clutch

- 8kW cooling capability with 155cc displacement
- Speed range 700 - 6000 rpm
- Suitable for R134a refrigerant with Sanden SP-10 oil
- Ear mount and direct mount options
- Available in 12 and 24 volt
- Numerous clutch and cylinder head options
- Flex mount cylinder head

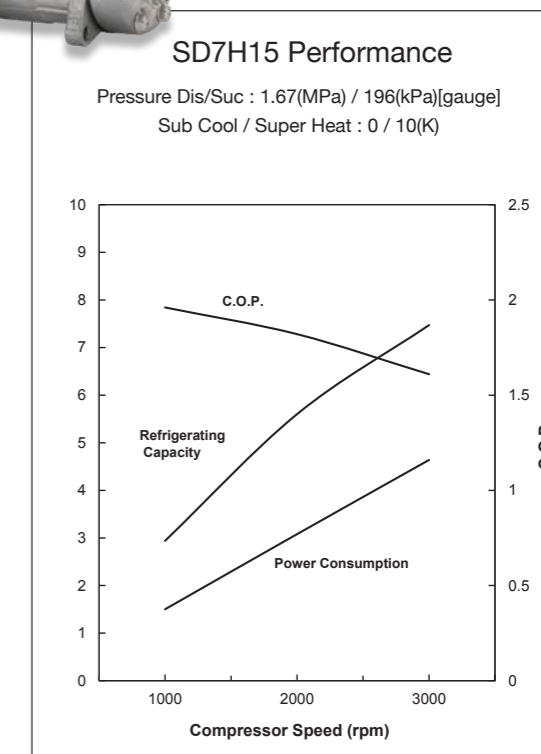
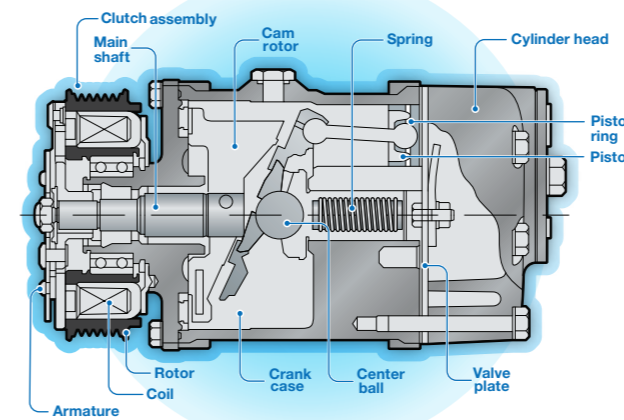

SD7H15 Enhanced

Standard 7 piston wobble plate design compressor with magnetic clutch

- Performance similar to 210cc compressor from 155cc displacement (10kW+)
- Speed range 700 - 6000 rpm
- Suitable for R134a refrigerant with Sanden SP-10 oil
- Ear mount and direct mount options
- Available in 12 and 24 volt
- Numerous clutch and cylinder head options

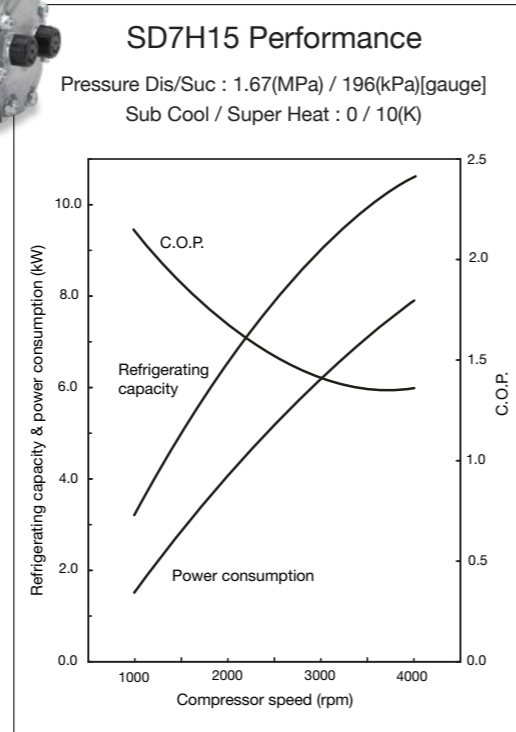
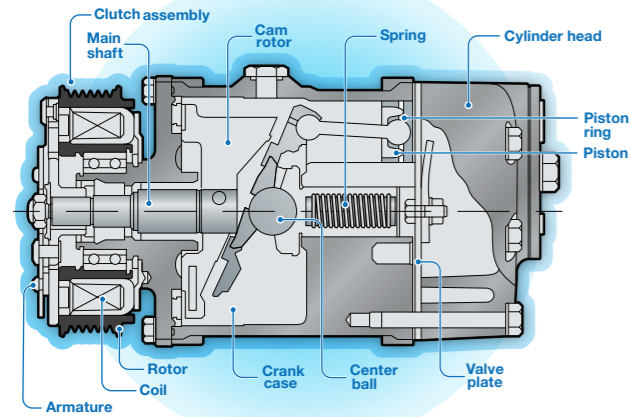

SD5L14

Standard 5 piston wobble plate design compressor with magnetic clutch

- 12kW cooling capability with 140cc displacement
- Speed range 700 - 3000 rpm
- Suitable for R404a refrigerant, for use with POE VG 68 oil, supplied without oil charge
- Ear mount design for easy fitting to bracket
- Available in 12 and 24 volt
- Numerous clutch and cylinder head options
- Enhanced casting for robustness
- Upgraded seals

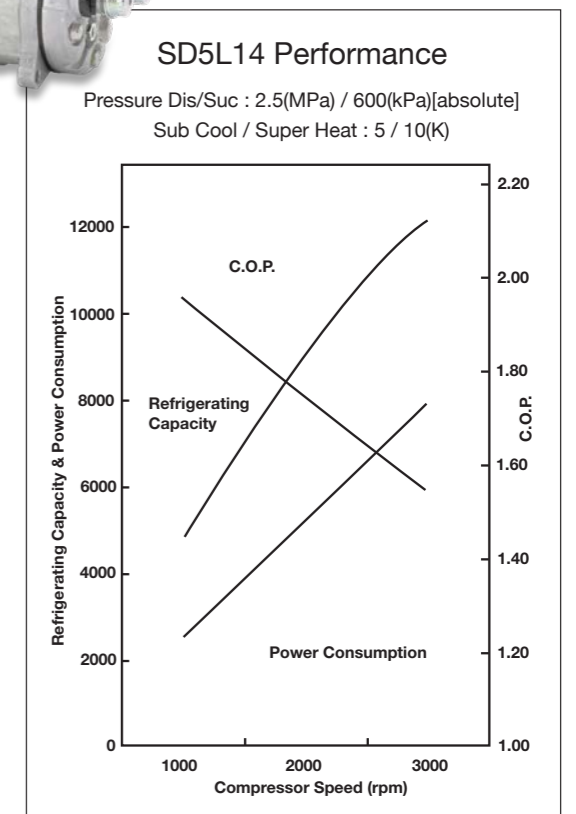
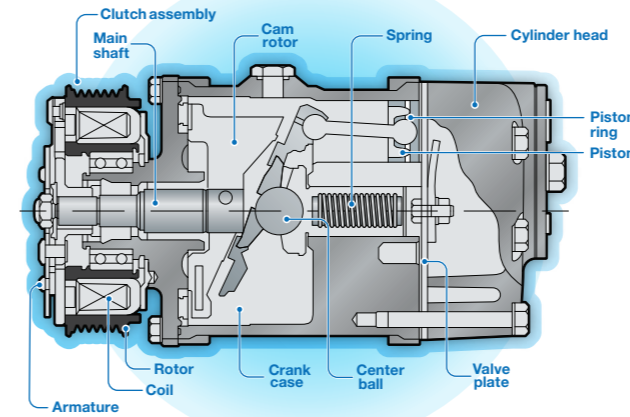

SDL

SD5L09

Standard 5 piston wobble plate design compressor with magnetic clutch

- 8kW cooling capability with 90cc displacement
- Speed range 700 - 3000 rpm
- Suitable for R404a refrigerant, for use with POE VG 68 oil, supplied without oil charge
- Ear mount design for easy fitting to bracket
- Available in 12 and 24 volt
- Numerous clutch and cylinder head options
- Enhanced casting for robustness
- Upgraded seals

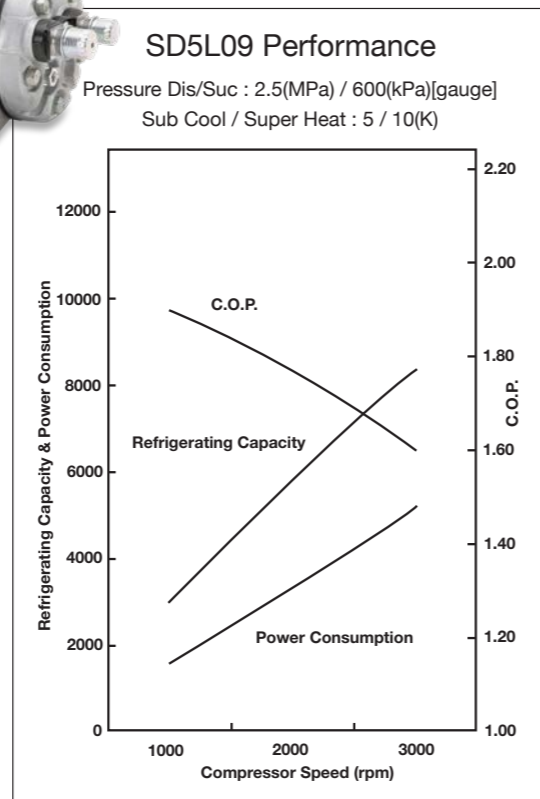
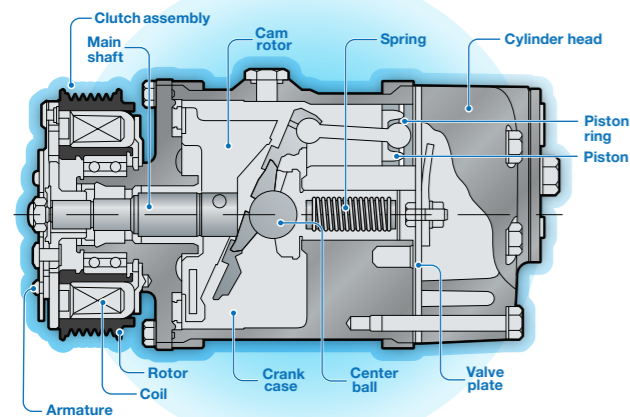

SD7L15

Standard 7 piston wobble plate design compressor with magnetic clutch

- 10kW cooling capability with 154cc displacement
- Speed range 700 - 3000 rpm
- Suitable for R404a refrigerant, for use with POE VG 68 oil, supplied without oil charge
- Ear mount design for easy fitting to bracket
- Available in 12 and 24 volt
- Numerous clutch and cylinder head options
- Enhanced casting for robustness
- Upgraded seals

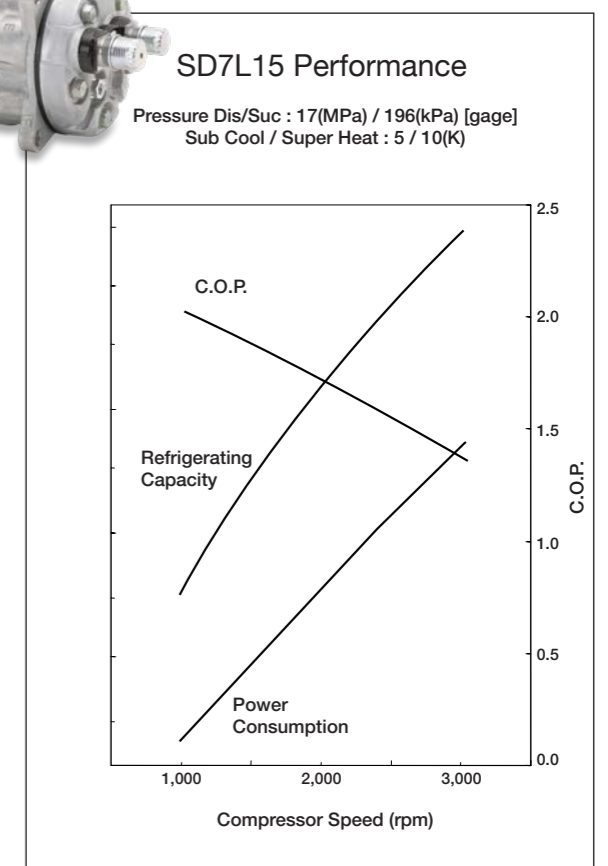
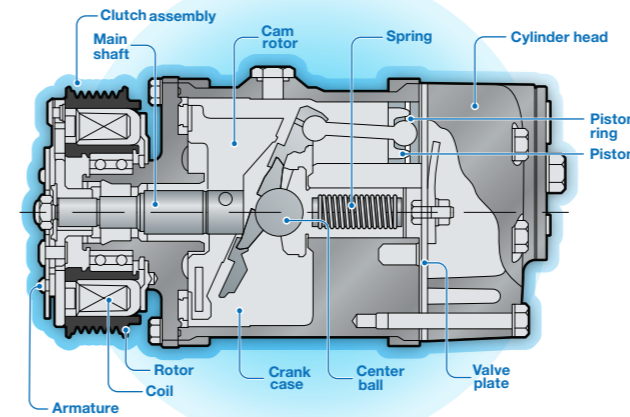

TURBO ROTARY SCROLL

TURBO ROTARY SCROLL

Rotary scroll fixed displacement compressor with clutch

- Compressor capacity from 50cc through 120cc
- Up to 10kW maximum continuous RPM 12,000
- Suitable for R134a refrigerant and Sanden SP-10 oil
- Option with oil separator
- Direct mount
- Available in 12 volt
- Original equipment parts

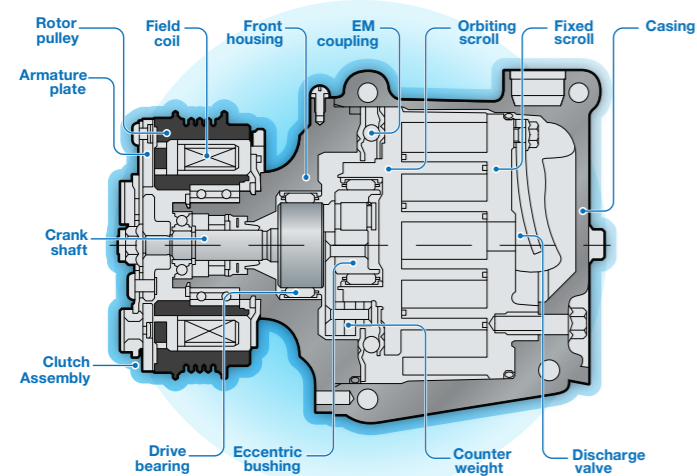

TRSA12 Performance

Pressure Dis/Suc :
1.67(MPa) / 196(kPa)[gauge]
Sub Cool / Super Heat : 0 / 10(K)

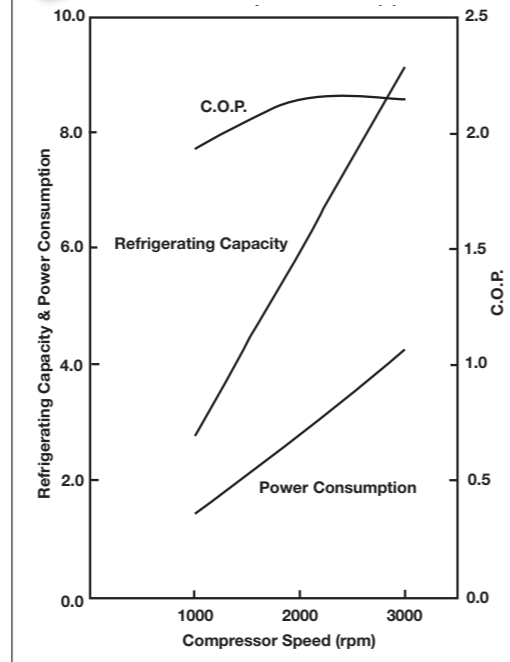

ELECTRIC COMPRESSOR

ELECTRIC COMPRESSOR

Next generation full electric semi hermetic compressor with integrated inverter

- 8kW cooling capability from 33cc displacement
- Maximum continuous RPM 8,000
- Suitable for R134a refrigerant and R1234yf refrigerant with Sanden SP-A2 oil
- Direct mount
- Available in 288v and 24v*, CAN or LIN software control
- Original equipment parts

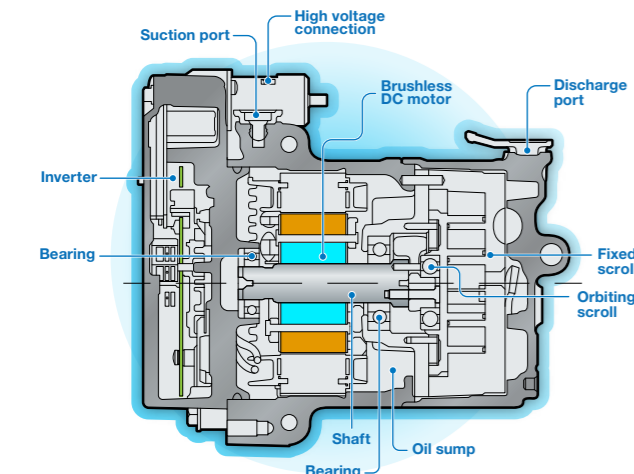

SHS33 Performance

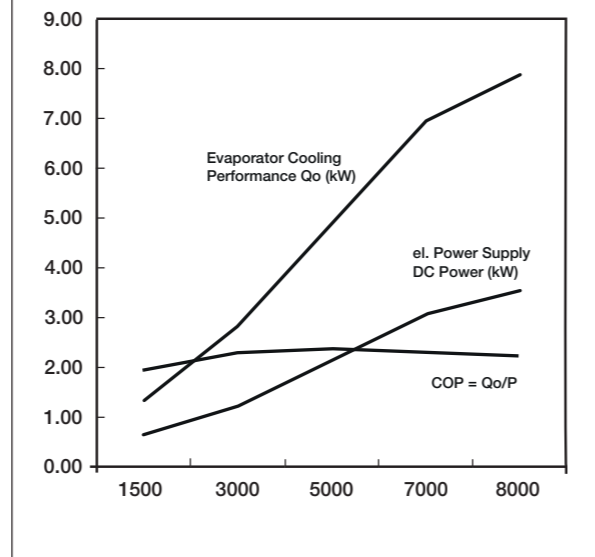

PX

PXE14

6 piston external variable swash plate design compressor with mechanical torque limiter

- 8kW cooling capability with 137cc displacement
- Speed range 700 - 9500 rpm
- Suitable for R134a refrigerant with Sanden SP-10 oil (pre 2016) and R1234yf refrigerant with Sanden SP-A2 oil
- Direct mount
- Available in 12 volt
- Original equipment parts

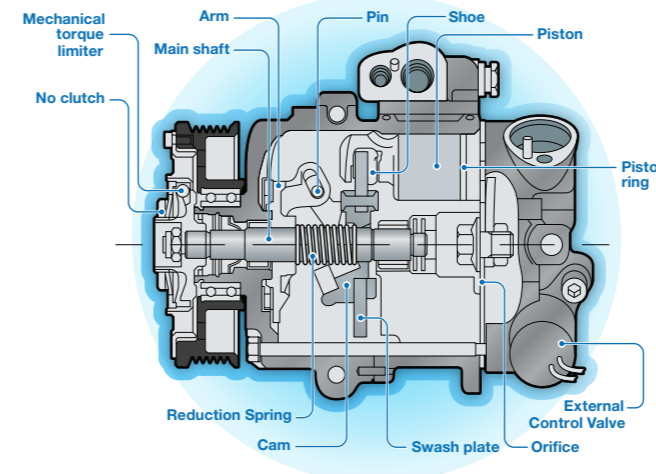

PXE14 Performance

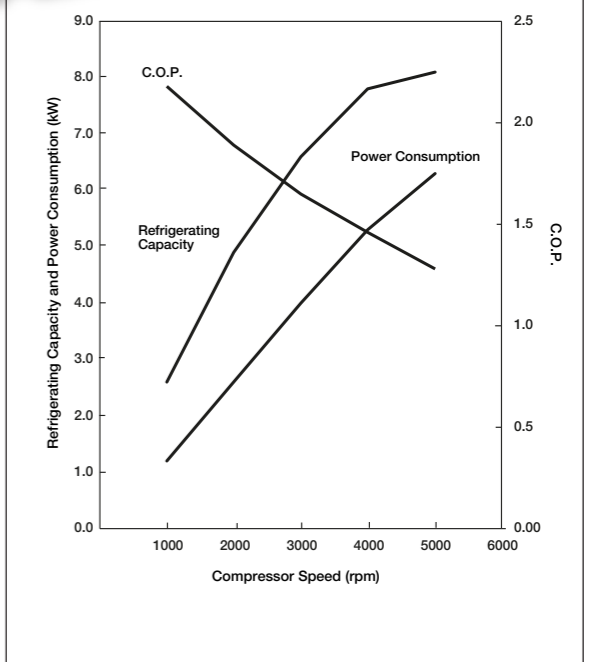

PXE16

7 piston external variable swash plate design compressor with mechanical torque limiter

- 9kW cooling capability with 167cc displacement
- Speed range 700 - 9500 rpm
- Suitable for R134a refrigerant with Sanden SP-10 oil (pre 2016) and R1234yf refrigerant with Sanden SP-A2 oil
- Direct mount
- Available in 12 volt
- Original equipment parts

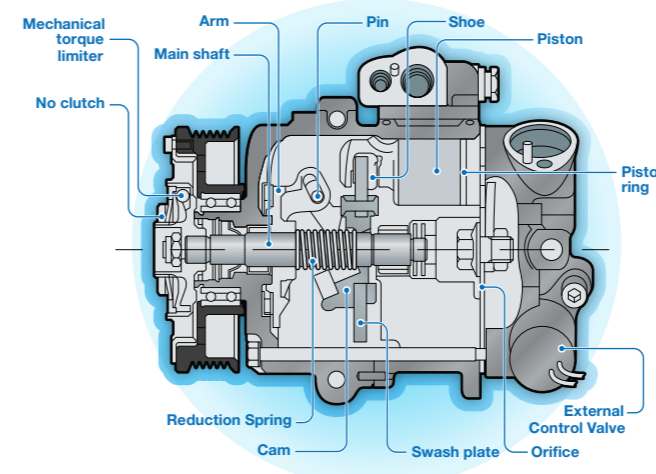

PXE16 Performance

Pressure Dis/Suc : 1.67(MPa) / 196(kPa)[gauge]
Sub Cool / Super Heat : 0 / 10(K)

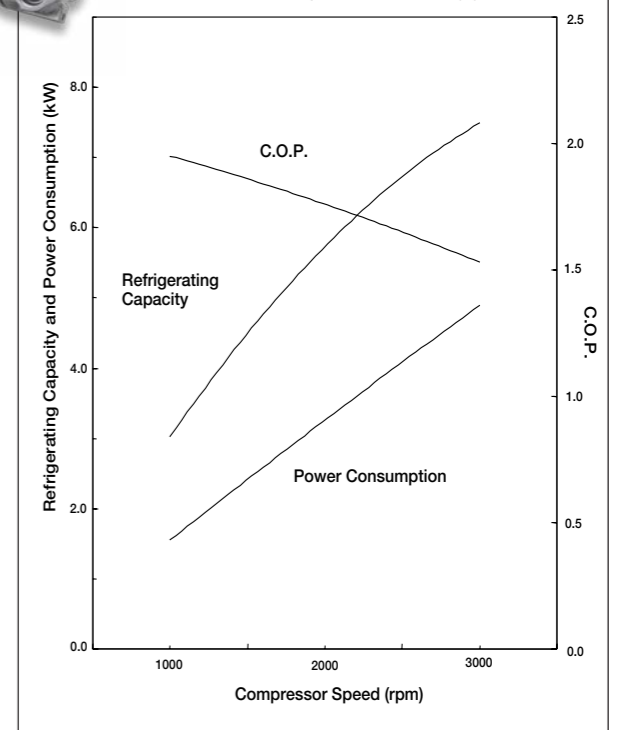

PXV16

7 piston external variable swash plate design compressor with mechanical clutch

- 9kW cooling capability with 167cc displacement
- Speed range 700 - 8500 rpm
- Suitable for R134a refrigerant with Sanden SP-10 oil (pre 2016) and R1234yf refrigerant with Sanden SP-A2 oil
- Direct mount
- Available in 12 volt
- Original equipment parts



PXV16 Performance

Condition : Pd / Ps= 1.67 / 0.197 MPaG,
Subcool = 0K / Super heat = 10K

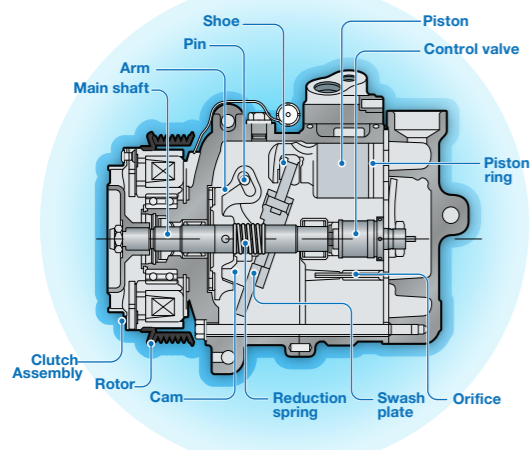
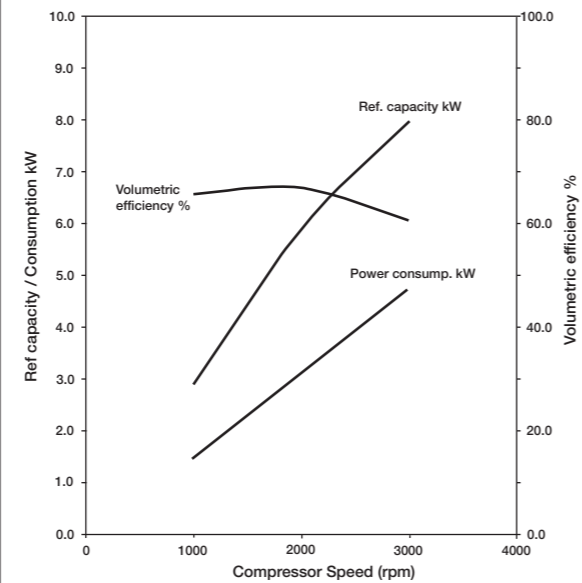

PXC16

7 piston external variable swash plate design compressor with mechanical torque limiter

- 9kW cooling capability with 167cc displacement
- Speed range 700 - 9500 rpm
- Suitable for R134a refrigerant with Sanden SP-10 oil (pre 2016) and R1234yf refrigerant with Sanden SP-A2 oil
- Direct mount
- Available in 12 volt
- Original equipment parts



PXC16 Performance

Pressure Dis/Suc : 1.67(MPa) / 196(kPa)[gauge]
Sub Cool / Super Heat : 0 / 10(K)

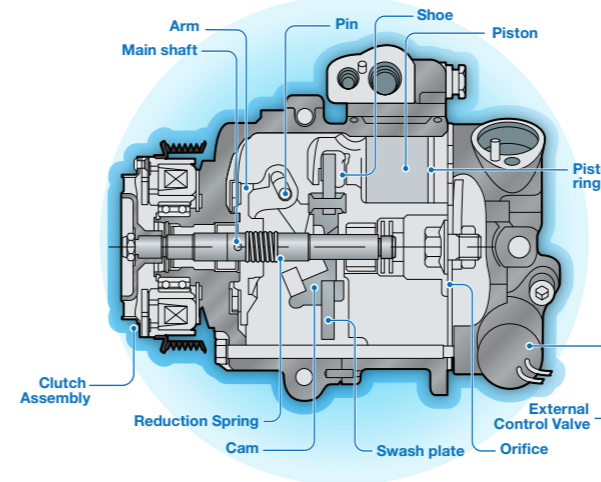
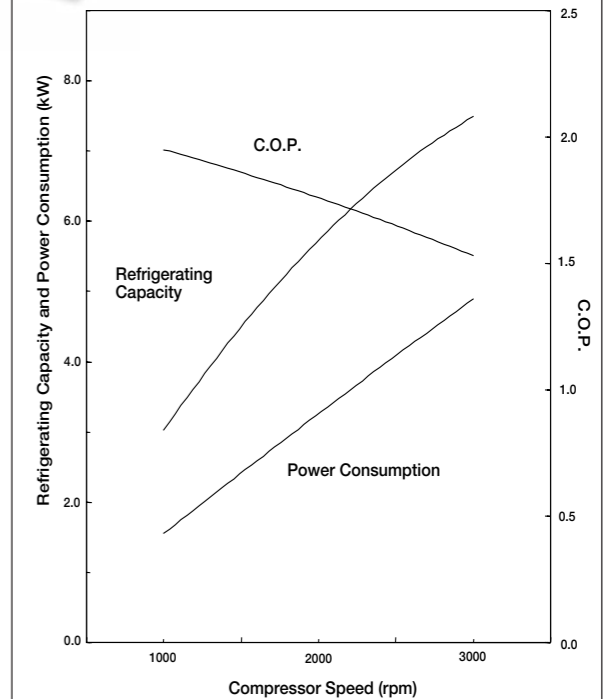

PXC14

6 piston external variable swash plate design compressor with magnetic clutch

- 8kW cooling capability with 137cc displacement
- Speed range 700 - 9500 rpm
- Suitable for R134a refrigerant with Sanden SP-10 oil (pre 2016) and R1234yf refrigerant with Sanden SP-A2 oil
- Direct mount
- Available in 12 volt
- Original equipment parts



PXC14 Performance

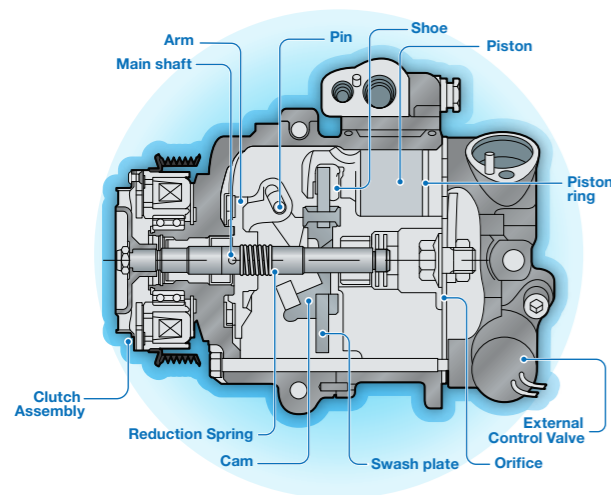
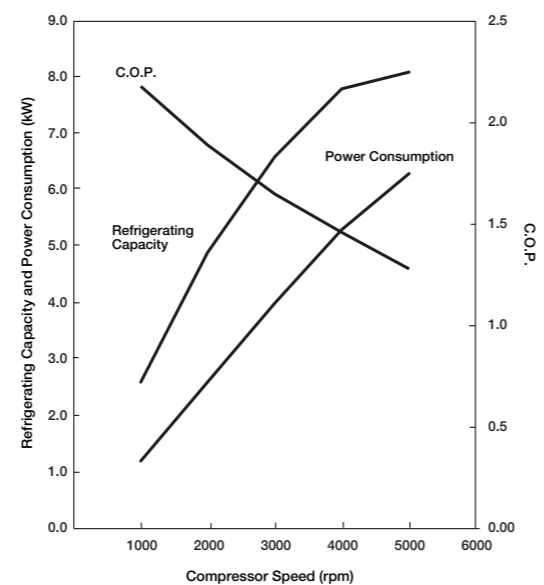

SDV

SD6V12

6 piston internal variable wobble plate design compressor with magnetic clutch

- 6kW cooling capability with 125cc displacement
- Speed range 700 - 8500 rpm
- Suitable for R134a refrigerant with Sanden SP-10 oil and R1234yf refrigerant with Sanden SP-A2 oil
- Ear mount and direct mount
- Available in 12 volt
- Original equipment parts



SD6V12 Performance

Pressure Dis/Suc : 1.7(MPa) / 196(kPa)[gauge]
Sub Cool / Super Heat : 0 / 10(K)

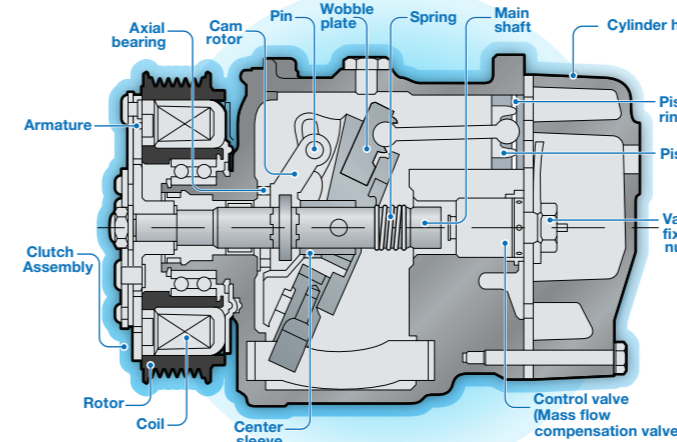
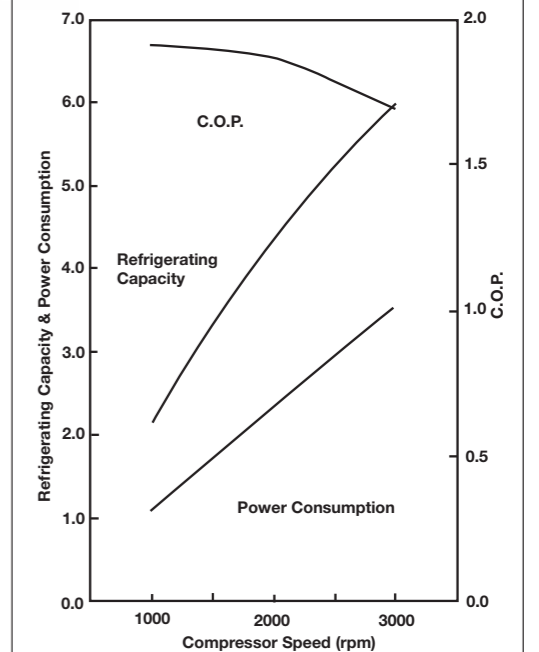

SD7V16

7 piston internal variable wobble plate design compressor with magnetic clutch

- 7kW cooling capability with 160cc displacement
- Maximum continuous RPM 8,000
- Suitable for R134a refrigerant and Sanden SP-10 oil
- Direct mount
- Available in 12 volt
- Original equipment parts

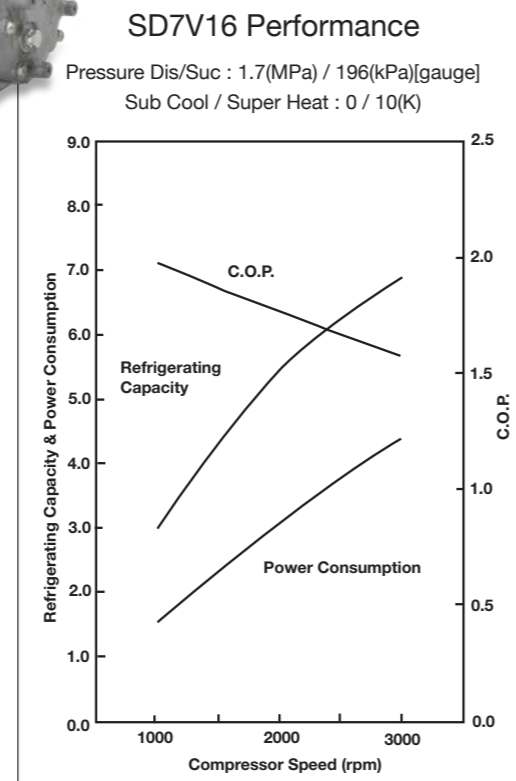
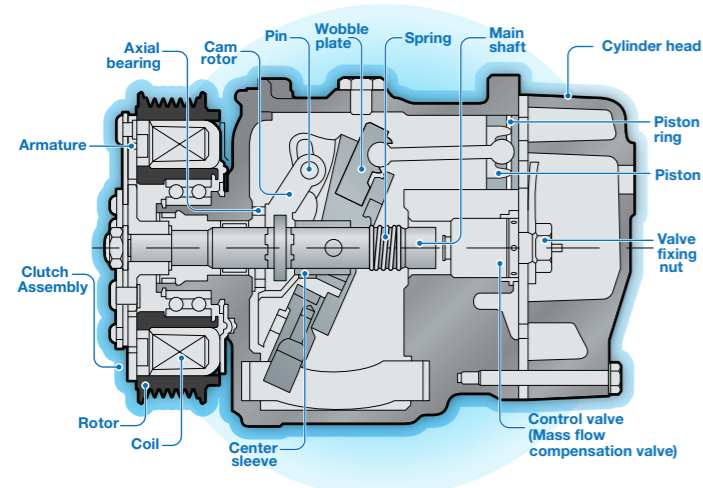

SD7C16

7 piston external variable wobble plate design compressor with magnetic clutch

- 7kW cooling capability from 160cc displacement
- Speed range 700 - 8500 rpm
- Suitable for R134a refrigerant with Sanden SP-10 oil and R1234yf refrigerant with Sanden SP-A2 oil
- Ear mount and direct mount
- Available in 12 volt
- Original equipment parts

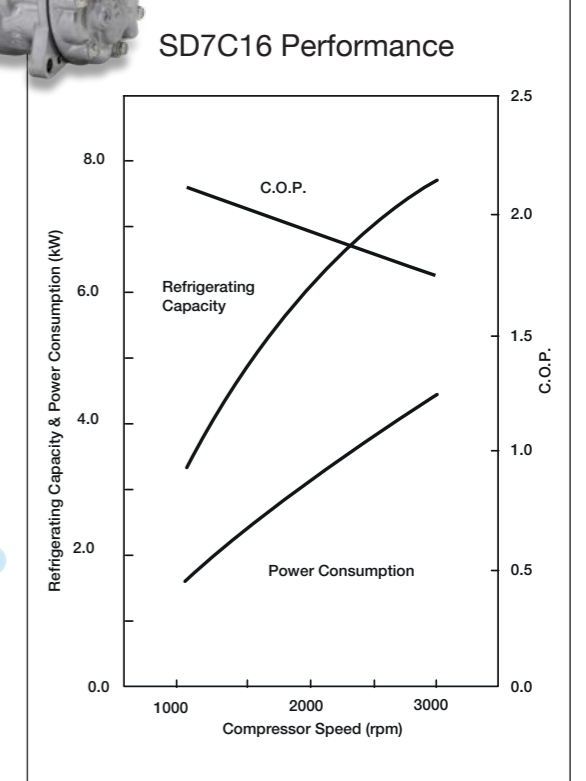
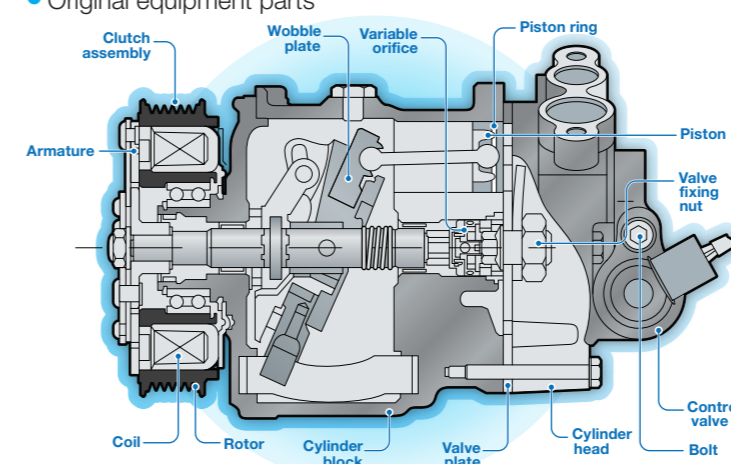

SDC

SD6C12

6 piston external variable wobble plate design compressor with magnetic clutch

- 6kW cooling capability from 125cc displacement
- Speed range 700 - 8500 rpm
- Suitable for R134a refrigerant with Sanden SP-10 oil and R1234yf refrigerant with Sanden SP-A2 oil
- Ear mount and direct mount
- Available in 12 volt
- Original equipment parts

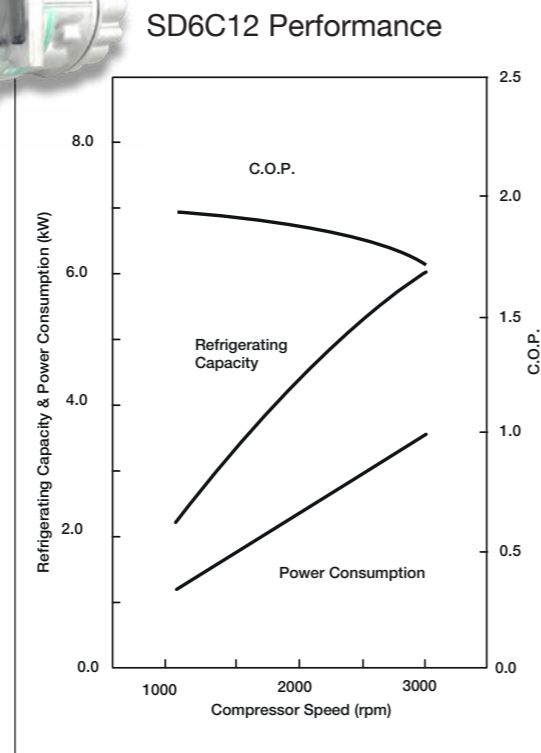
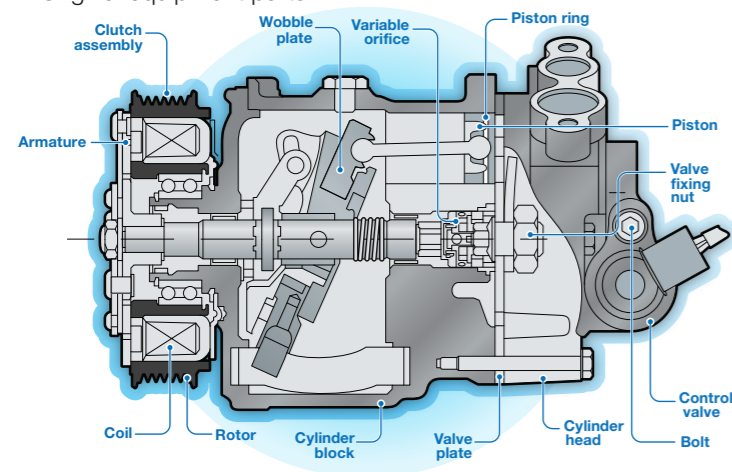
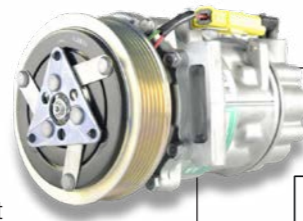

HEAVY DUTY

HEAVY DUTY

Heavy Duty 7 piston wobble plate design compressor with magnetic clutch

- 8kW cooling capability with 155cc displacement
- Speed range 700 - 6000 rpm
- Suitable for R134a refrigerant with Sanden SP-10 oil
- Ear mount and direct mount options
- Available in 12 and 24 volt
- Numerous clutch and cylinder head options for Super and Semi Super Heavy Duty application
- Clutch with friction liner and thermal fuse
- Enhanced durability with dust protection

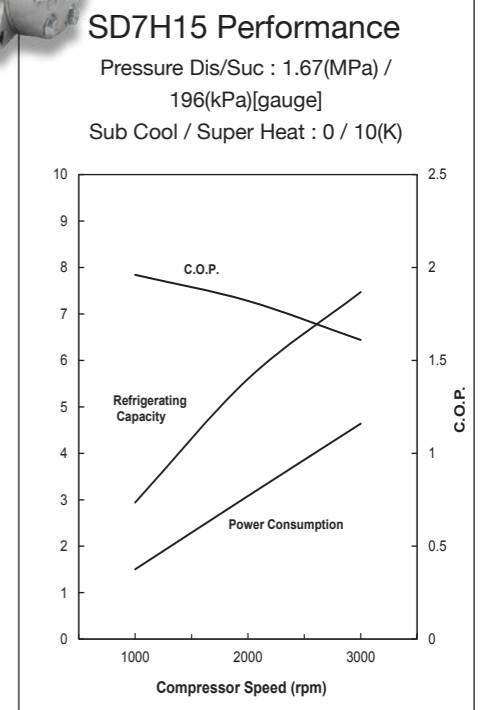
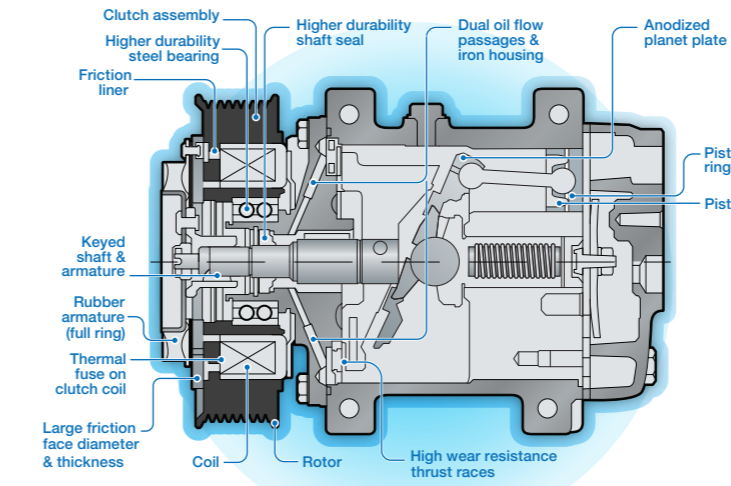



DID I BUY A GENUINE SANDEN?

COUNTERFEIT LABEL



This label is not correct - see below

- 1 Barcode style is not used
- 2 Label has wrong colour green
- 3 Label does not specify oil type or refrigerant
- 4 Sanden is spelled incorrectly, e.g. 'SANDAN'

COUNTERFEIT



GENUINE LABEL



This label is genuine - see below

- 1 The SANDEN Holospot® 6-digit code (e.g. 'BCD123') is unique and different on each product item
- 2 The 6-digit code matches the 2D barcode and 6-digit code (e.g. 'BCD123') imprinted next to the SANDEN Holospot
- 3 Label specifies refrigerant type and oil type
- 4 Correct font is used

GENUINE



COUNTERFEIT BOX



1 Counterfeit box is without model number and serial number, Sanden logo has incorrect formatting



2 Printing is poorly formatted, wrong font and style

GENUINE BOX



1 Genuine box will have model number and serial number printed here
 2 Correct font and formatting will be used

COUNTERFEIT CASTING



1 Compressor body is too shiny
 2 Features charge ports on the cylinder head
 3 Sanden emboss is missing from the compressor body and cylinder head casting

GENUINE CASTING



1 Compressor body has dull sheen
 2 Does not have charge ports on cylinder head

3 Features a Sanden emboss on the compressor body and cylinder head casting*

*Only applicable to Sanden SD5S models



Sanden International (Australia) Pty. Ltd.

Unit 6, 17 Willfox Street, Condell Park, NSW, 2200, Australia.

Phone: 61 - 2 - 9791 0999 www.sanden.com.au email: sales@sanden.com.au

SIEUK180059A